



A New Gas Chromatography Method for Continuous Monitoring of Non-methane Hydrocarbons as an Analogy of Volatile Organic Compounds in Flue Gas

Chieh-Heng Wang¹, Hsi-Che Hua², Wei-Chuan Lin², Hsin-Cheng Hsieh², Jia-Lin Wang^{2*}

¹ Center for Environmental Studies, National Central University, Taoyuan 32001, Taiwan

² Department of Chemistry, National Central University, Taoyuan 32001, Taiwan

ABSTRACT

A new on-line method of monitoring the total non-hydrocarbons (TNMHC) from the flue or waste gas of stationary sources, which significantly improves upon the current method commonly used in both Taiwan and China, is described. The major problem with the current method is that higher-boiling-point compounds in the waste gas saturate porous materials within the molecular-sieve column used to immobilize TNMHC and elute methane, which sabotages the fixability of TNMHC and leads to false methane and TNMHC readings during continuous monitoring. Our new method effectively circumvents this issue by incorporating a dual-column and back-flush design, rendering it a true gas chromatography (GC) method. Applying this GC method, light hydrocarbons, such as methane, ethane, and propane, can be fully separated by the dual column set. After methane enters the analytical column, a reverse carrier flow immediately back-flushes the pre-column while keeping the analytical column flowing forward by a second flow of the carrier gas for eluting methane. The field application, particularly upon repeated analyses of flue gas laden with complex and elevated levels of volatile organic compounds (VOCs), has shown that self-cleaning by back-flush is necessary when operating at a constant oven temperature.

Keywords: Volatile organic compounds (VOCs); Flue gas; Continuous emission monitoring system (CEMS).

INTRODUCTION

Volatile organic compounds (VOCs) are a comprehensive term for numerous organic compounds with sufficiently low boiling points and thus high volatility. The volatility of a VOC species is dependent on its molecular size or carbon number in the chemical structure. The abundance of a VOC in ambient air is determined not only by volatility but also by emissions and the atmospheric lifetime, which is controlled by chemical and physical removal rates (Kwok and Atkinson, 1995; Markelj and Pompe, 2016). While all VOCs are carbon compounds, hydrogen is another common element bound to their structures, and if only these two elements are found in the molecules, they are named hydrocarbons (HCs). Other elements, e.g., oxygen, nitrogen, halogens, and sulfur, can also be present, producing different chemical properties from those belonging to HCs and thus causing different environmental issues, such as foul odors, toxicity, and global warming. Depending on their reactivity to oxidants, such as hydroxyl and nitrate radicals, most VOCs are also precursors of surface ozone

(Alastair *et al.*, 2000; Placet *et al.*, 2000) and fine aerosols (O'Dowd *et al.*, 2002; Hallquist *et al.*, 2009; Chen *et al.*, 2011; Hatfield and Huff Hartz, 2011; Vivanco *et al.*, 2011) as a prominent part of the secondary pollutants, which are often worse in health effect than their precursors of primary in nature (Wichmann *et al.*, 2009; Tsai *et al.*, 2010; Lin and Kuo, 2013; Yorifuji *et al.*, 2013; Shin *et al.*, 2015).

The sources of atmospheric VOCs are numerous and can be divided into two large groups of anthropogenic versus biogenic, of which the anthropogenic group can be further classified into stationary and mobile sources. While the mobile sources are mainly addressed to on-road vehicles, the stationary sources are primarily industrial, and both types of emissions can be controlled through technical and regulatory means with an aim to improve air quality. One of the most effective regulatory means to regulate industrial VOC emissions is to set emission standards for selected industries and, in some cases, to further collect emission fees for these high-emission industries (Clean Air Act Amendments, 1990; Lee, 1991; Ruch and Howeli, 1991; Popp, 2003), such as petrochemical, semiconductor, flat panel manufacturers, painting, etc. Continuous monitoring of VOCs in waste gas or flue gas of these industries is an important part of the regulatory practice, which is called continuous emission measurement system (CEMS) (U.S.EPA, 1975; Jahnke, 2000). The CEMS had been

* Corresponding author.

E-mail address: cwang@cc.ncu.edu.tw

successfully implemented for SO₂ and NO_x worldwide (Svendsen, 1998; Farrell *et al.*, 1999; Napolitano *et al.*, 2007; Zhang and Schreifels, 2011), and was recently applied to VOCs to provide a quantitative way to gauge VOCs in flue gas (Ellerman, 2000; Zevenhoven and Kilpinen, 2001; Chestnut and Mills, 2005). Based on CEMS's results, the emitted quantities are measured in compliance with the emission standards. Overall, CEMS is an effective part of the integrated effort to control emissions and improve air quality.

The CEMS for VOCs is a gas chromatography (GC) technique, designed to measure the total abundance of VOCs in the waste gas of stationary sources (McAlister, 1987; Zhou *et al.*, 2018). To simplify and ensure reliable measurement, the CEMS uses flame ionization detection (FID) for on-line GC analysis. The simplicity of this technique lies in the determination of VOC mixing ratios using FID to serve as a "carbon counter." By calibrating with the known mixing ratio of methane standard, the VOC mixing ratio of methane equivalence in flue gas is obtained.

The success of the FID based method lies in the removal of methane in analysis. Methane is not counted as a VOC due to its extremely low reactivity to form secondary pollutants (Atkinson, 1986; Gery *et al.*, 1989). For instance, methane's reactivity is much lower than that of ethane (Atkinson, 2000; Kondratiev and Nikitin, 2012), the least reactive VOC, by a magnitude of two. Thus, methane is not considered as a VOC to affect air quality. Furthermore, methane could be a major constituent in flue gas since it is a major component in natural gas commonly used as a fuel to burn off the enriched VOCs in the combustive types of scrubbers, such as a regenerative thermal oxidizer (RTO). Therefore, its presence in flue gas could be significant if combustion is not complete. As a result, separation of methane from other VOCs in the sample is pivotal to the robustness of a CEMS method. Separation of methane from VOCs requires elution from GC to be kept at an elevated temperature, for instance 150°C, to prevent condensation of high-boiling-point VOCs. A typical aliquot of a flue gas sample would result in two signals of total HC (THC) and methane and thus, by subtracting the methane mixing ratio from the THC mixing ratio (of methane equivalence) yields the mixing ratio of total non-methane hydrocarbons (denoted as TNMHC) (Eq. (1)).

$$\text{TNMHC} = \text{THC} - \text{CH}_4 \quad (1)$$

where

TNMHC = FID signal of total non-methane hydrocarbons;

THC = FID signal of total hydrocarbons;

CH₄ = FID signal of methane.

Erroneous results or bias in the measurements could result from either one of the following two possibilities. First, the separation of methane is not complete and other small molecules of VOCs, e.g., ethane, ethanol, acetone, etc., co-eluted with methane and together is counted as "methane." Such an overestimate of methane would subsequently result in an underestimate of the TNMHC

level by referring to Eq. (1). The second possibility would be the opposite of the first, that is, methane is underestimated from analysis, and consequently, the TNMHC level is overestimated. This problem could arise from the saturation of the filter column, which is a piece of metal tubing packed with porous materials such as molecular sieve (MS) to act as a filter to immobilize TNMHC and let methane pass through. The continuous operation of the method in the on-line mode over time would lead to gradual saturation of the porous materials in the filter column and eventually loss of separation efficiency of the filter column. The first possibility is caused by a fraction of NMHC, possibly lighter fraction, passing through the filter column to combine with methane due to the degrading separation power, leading to false positive error (overestimation) for methane and therefore false negative error (underestimation) for TNMHC. The second possibility is the worsening peak shape of methane caused by the gradual saturation of the filter column, resulting in unsuccessful recognition and integration of the methane peak by the integration algorithm. In this case, the methane level would be reported as a near zero value and thus an overestimate of TNMHC occurs. The aforementioned two possibilities are all rooted to saturation of the porous materials in the filter column when operated in CEMS mode. In this work, a modified method is introduced to eliminate the two possibilities arising from the faulty design based on filtration.

EXPERIMENTAL

The current government recognized monitoring method implemented at Taiwan and China adopt foregoing filtration mechanism (EPA, ROC, 2011; EPA, CN, 2017). To facilitate understanding the new method, Fig. 1 illustrates the conceptual schematics of the existing filtration method. The sample aliquots filled within the two sample loops of equal volumes are flushed by the carrier gas (zero air or nitrogen) into two approximately equal flows. One flow goes to a "dummy" column, which can be an unpacked stainless steel (s.s.) tube with a flow restrictor, or an s.s. tube packed with fine passivated glass beads to balance out the resistance from the analytical channel (Fig. 1(a)). This dummy column has no chemical force and therefore does not exert any separation power and only gives rise to the signal of THC, containing methane. The other analytical channel is a column packed with molecular sieve (MS-5A, 1 m × 2.0 mm I.D.) kept at 150°C oven temperature used to separate methane from TNMHC, called the methane filter. Due to the small molecular size of methane, it penetrates the MS column and leave behind larger molecules of VOCs. For the two parallel columns in Fig. 1(b), the THC peak would elute faster from the dummy column than the methane peak eluting from the MS column due to the smaller impedance of the dummy column. Only two peaks are observed from each injection of GC analysis, i.e., THC and methane, and the result of TNMHC is acquired by subtracting the THC mixing ratio with the methane mixing ratio.

Similar to the filtration method, the new method is a GC-based technique. However, different from the filtration

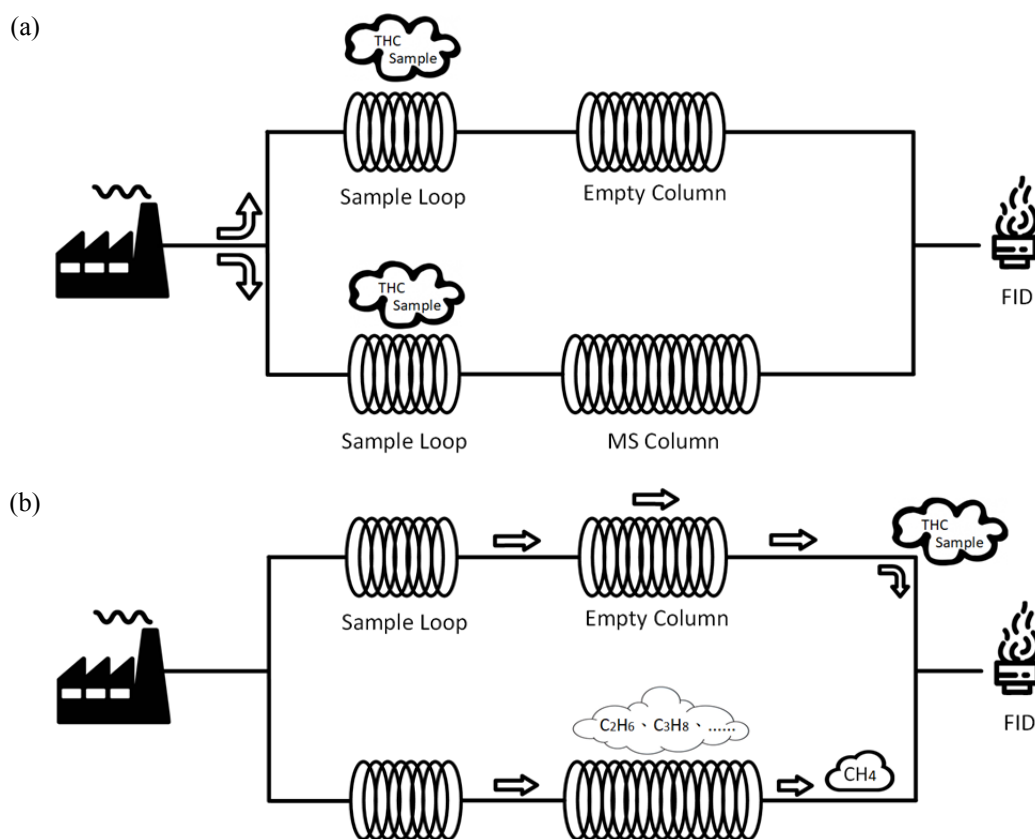

Fig. 1. Schematics of the filtration method during the sample injection stage (a) and the analysis stage. Methane is eluted out of the MS column while other NMHCs are trapped in the MS column (b). MS Column stands for the molecular sieve column and the empty column is an empty s.s. tube.

method which uses two separate sample loops with identical volumes, our new method uses only one sample loop and splits the sample aliquot into two flows to the methane channel and the dummy channel (Fig. 2(a)). The basic working principle is still the same in accordance with Eq. (1); however, the analytical channel (or methane channel) for separating methane from TNMHC is different. The methane channel is formed by two columns, namely a pre-column packed with a porous material called Sorptive X ($1.0 \text{ m} \times 2.1 \text{ mm I.D.}$) connecting with an analytical column packed with Sorptive Y ($0.3 \text{ m} \times 2.1 \text{ mm I.D.}$) in series kept at 150°C . The dual-column configuration is different from the single column design adopted in the filtration method. The dual-column design is to perform methane separation by flowing the sample through the dual-column set (Fig. 2(b)). Immediately after methane is separated and has been eluted to the analytical column, the back-flush step is executed and the two columns are now disconnected to allow elution to occur simultaneously and independently (Fig. 2(c)). Within the analytical column, methane is continued to be pushed forward and then eluted out to FID to produce the signal of methane. Simultaneously, while methane is eluting from the analytical column, another flow of carrier gas flushes the pre-column from the opposite end to create a reversed flow to flush all VOCs to vent (Fig. 2(c)). At this point, the GC system is ready for the next analysis.

To test the new back-flush method, a standard mixture

containing methane, ethane and propane at 10 ppm (v/v) were tested, and the results are shown in the following section. Another standard mixture containing methane and propane at methane 900 ppm (v/v) and propane 9000 ppm (v/v) were tested for quality assurance.

RESULTS AND DISCUSSION

Method Validation

The back-flush dual-column is a typical GC technique when working at a fixed oven temperature. The major advantages of this design are speed and simplicity. Temperature ramping for higher separation power to separate a complex mixture is not needed in this particular application, since only methane separation is required. Because temperature ramping is time consuming, the fixed-temperature back-flush design can substantially reduce the analysis time. In our design, using narrow-bore s.s. columns (O.D. = $1/16''$), each analysis can be completed within one minute. When temperature ramping is not required, the GC parameters can be greatly simplified due to the omission of elaborate temperature-control hardware and software for the GC oven. When the isothermal concept is adopted, the dual-column back-flush mechanism become absolutely necessary in order to elute higher-boiling-point VOCs than methane. The dual-column back-flush design always refreshes the pre-column during each analysis to prevent

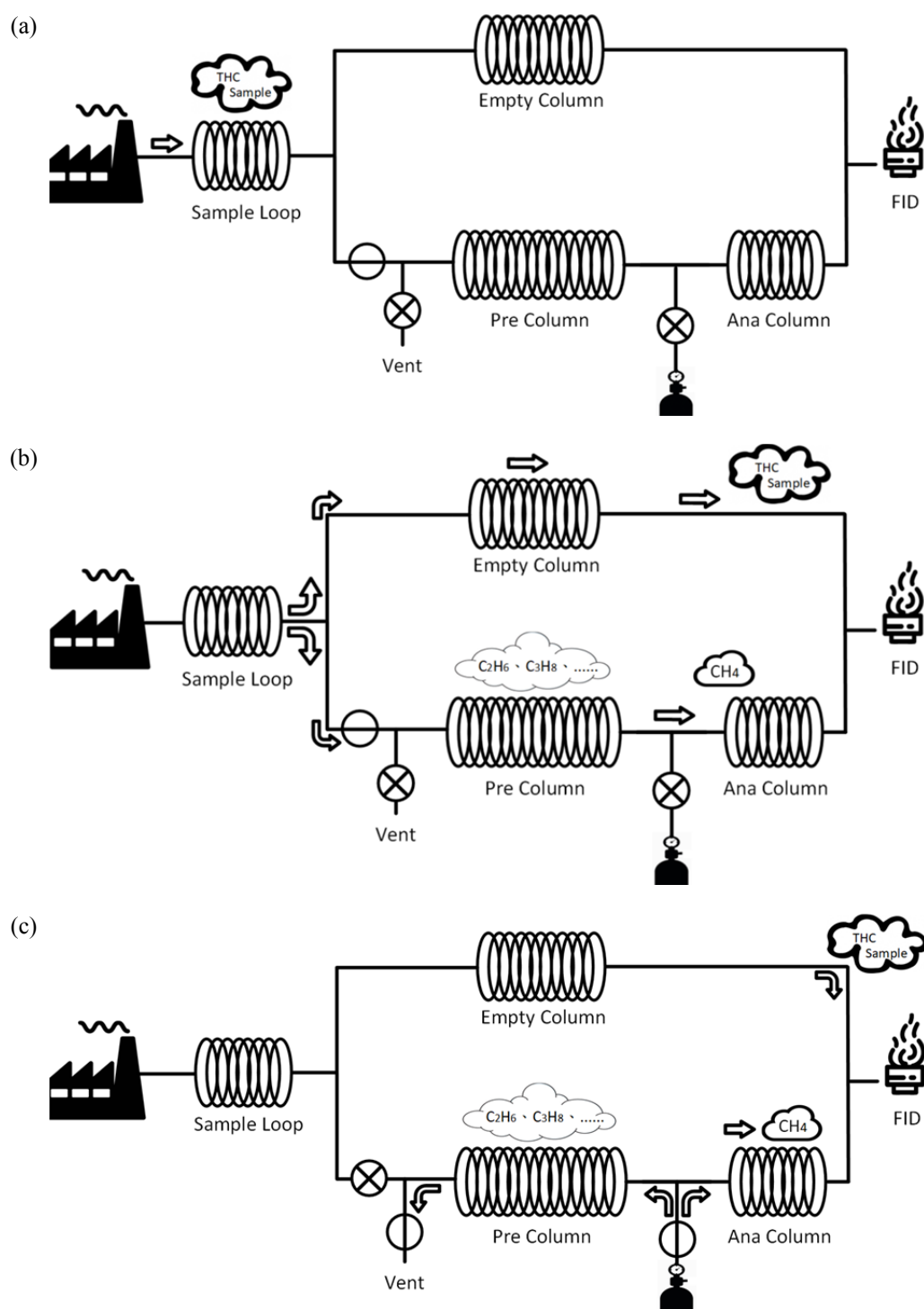

Fig. 2. Schematics of the dual-column GC method during (a) the sample filling stage, (b) the separation stage. Methane is separated and sent to the analytical column while NMHCs are left in the pre-column, and (c) the backflush stage. NMHCs are reversely flushed out of the pre-column while methane is eluting from the analytical column.

higher-boiling-point VOCs from accumulating in the column, resulting in the loss of separation efficiency and breakthrough of small molecules.

By contrast, the filtration method uses only a single MS column for methane separation, and no back-flush mechanism is incorporated. The MS column only acts as a VOC retainer to only allow methane to pass through due to

the small pore size of MS-5A. A common feature with the MS filter is that the porosity that holds up the undesired components can get saturated over time, and when the saturation point is reached, breakthrough is inevitable. Although, in theory, the methane filter can be prematurely replaced to avoid breakthrough and ensure clean filtration of methane, there would be no clear indication of the time

for premature replacement, since saturation would be circumstantial depending on the matrix conditions of the waste gas. Unless the system check is performed frequently, filter saturation from the normal CEMS reading cannot be easily detected when the system is used in a continuous mode. The system check can be performed by injecting a standard mixture of methane and ethane. If the response or peak shape of methane has changed compared to the earlier results, it could imply saturation has reached. With the methane filter method, the rate of saturation will depend on the nature of the waste gas. For the waste gas containing high levels of VOCs and dust, the lifetime of the methane filter would be shortened due to early saturation, which would call for more frequent system checks or even column replacements to avoid breakthrough, resulting in greater maintenance demands, logistic burden and greater cost in the

long run. Breakthrough is the primary reason to cause either over- or underestimates of methane and, consequently, bias in the TNMHC measurements.

Our back-flush method is a true GC method in the way that methane can be fully separated from TNMHC. To have an unambiguous separation, this method clearly demonstrates the separation of methane from ethane and propane, the very small molecules only second to methane in size (Fig. 3). When methane and ethane are clearly separated, the cutting point to perform back-flush can then be decided. In this example, 0.7 min is our cutting time which has to be earlier than the valley of 1.4 min between the two peaks. When the back-flush is performed, compounds after methane (in this case, ethane and propane) no longer flow to the analytical column and the resulted chromatogram only shows the peak of methane (Fig. 4). Instead of being

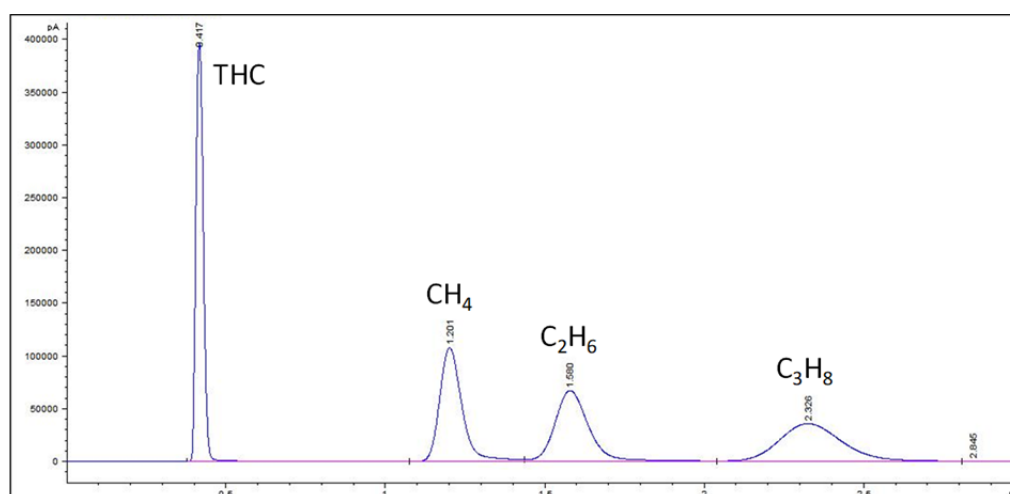

Fig. 3. GC trace of the standard mixture containing methane, ethane and propane. A complete separation of methane from ethane and even propane is clearly shown.

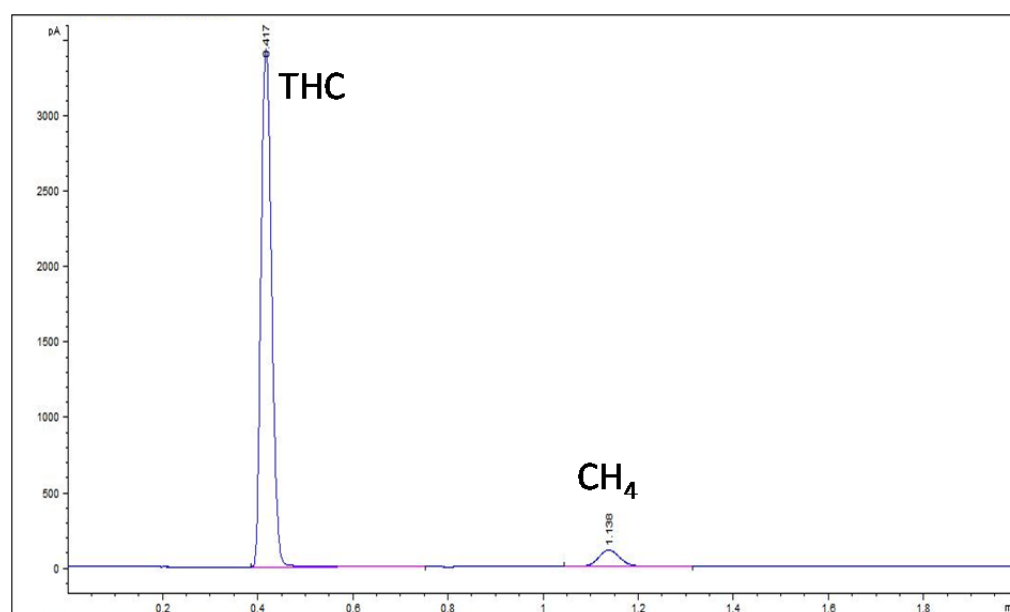

Fig. 4. Back-flush at 0.7 min to only allow methane to come out of the analytical column, while ethane and propane are reversely pushed out of the pre-column to vent. The first tall peak is total hydrocarbons and the second peak is methane.

flushed to the analytical column, ethane and propane, representing the higher-boiling-point VOCs, are all reversely flushed out of the pre-column to vent.

Quality assurance of the back-flush method is demonstrated by the linearity and reproducibility of the method by analyzing the standard gas mixture. The linearity was tested by filling the sample loop of 1.73 mL with standard gas of various mixing ratios to construct calibration curves for both THC and methane (Fig. 5). The precision as revealed by the error bars in Fig. 5 ranges from 0.05% to 0.75% (RSD) for methane and from 0.08% to 0.55% for THC based on five replicates ($N = 5$) of the five calibration points, which are well within the requirements of 25% as specified in the method of NIEA A723.73B. The detection limits based on 3 standard deviations were calculated to be 0.25 ppm for methane and 0.44 ppmC for THC based on seven replicates of the lowest mixing ratios of the five-point calibration curves (1 ppmC for methane and 2 ppmC for THC).

Field Test

The new method was tested in a semiconductor factory on a major house exhaust pipe. This pipe was used to vent

organic fumes from the manufacturing processes. To remove VOCs in the exhaust gas, a regenerative thermal oxidizer (RTO) as a scrubber was installed before the opening vent of the pipe. The removal efficiency of the scrubber and emissions at the opening was monitored by the system based on the existing method of filtration which had been operated for some years. Two monitoring points, before and after the RTO, were made with a time interval of 15 minutes to switch between the two points. For comparison, our back-flush method was also installed alongside the filtration method. The comparison was performed for a week continuously without interruption. In Fig. 6, a fraction of the dataset from the two instruments were compared for the mixing ratios of THC and methane at the inlet of the RTO to highlight the discrepancy. In Fig. 6(a), the THC level varied with time and both methods were able to see similar variations between 120–150 ppmC. In Fig. 6(b), the methane mixing ratio at the inlet showed large discrepancy between the two methods. Our new method showed a rather constant value around 1.5 ppmC, whereas the filtration method showed zero methane mixing ratio most of the time, except for a data point that abruptly rose to 1.5 ppmC at 15:30, but rapidly fell and remained at zero for the rest

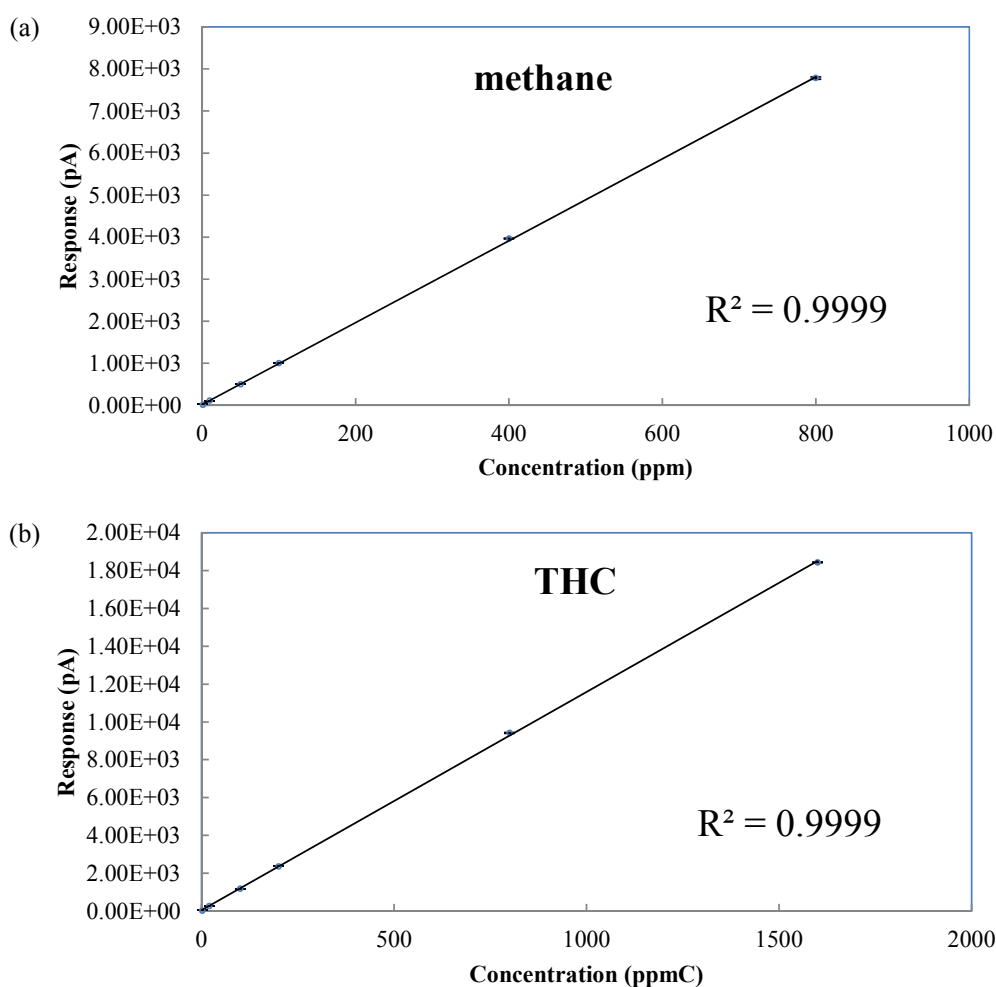

Fig. 5. Calibration curve constructed from 1, 5, 50, 100, 400, 800 ppm for methane (a); and 2, 10, 100, 200, 800 and 1600 ppmC for THC (b). Error bars on the curves are based on five repeated analyses ($N = 5$) of each standard gas.

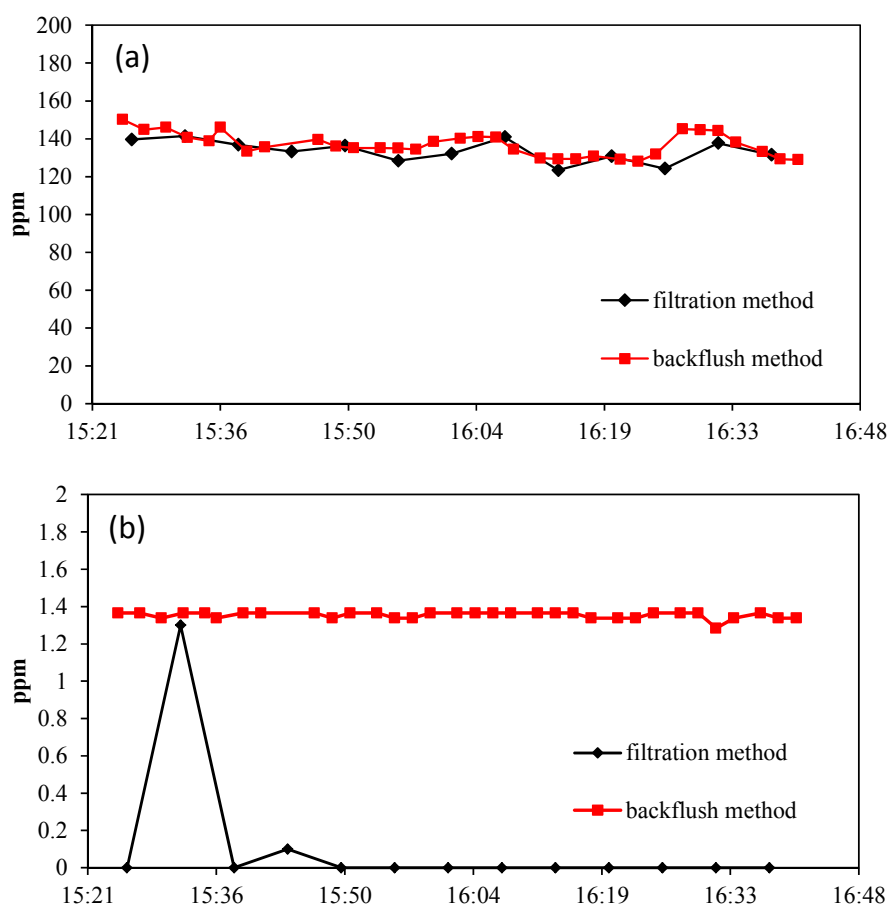

Fig. 6. Continuous monitoring before RTO in a semiconductor fabrication factory. (a) THC measurements; (b) methane measurements. The filtration method was switched between six sampling points of the stack, whereas our back-flush method was only switched between two sampling points, i.e., before and after the RTO unit, resulting in more data points than the filtration method.

of the monitoring period. Since natural gas was used as the fuel to bake off enriched VOCs from the RTO, trace level of methane ought to exist. As a result, the zero mixing ratios of methane detected by the filtration method seemed to be questionable. It was speculated that the saturation of the MS-5 column leading to the loss of absorptivity was the cause for not being able to detect methane. Although methane was able to pass the filter, the separation power was lost due possibly to saturation. The saturated MS material was behaving more like smooth solid spheres without sufficient micro-pores to absorb VOCs, resulting into poor peak shape of methane and, thus, undetectable methane level. For the inlet, since TNMHC is the net result of THC subtracting methane, the measured NMHC values would be similar between the two methods, approximately 120 to 150 ppmC, due to the low methane mixing ratios. Therefore, the consequence of underestimating methane level was minimal at the inlet of RTO. However, the consequence became more severe at the outlet. Fig. 7 shows the outlet mixing ratios for THC and methane from the two instruments. The THC mixing ratios were approximately 5 ppmC and thus, very low compared with the inlet level ranging between 120 and 150 ppmC, suggesting the RTO was at work to remove VOCs in the flue gas *with a removal*

efficiency greater than 95%. Again, the methane level was not successfully detected by the filtration method due possibly to saturation, in this case causing false negative bias in the methane measurements. Our back-flush method was able to consistently detect methane, showing similar mixing ratios to the inlet ones. An abrupt drop in methane level from 1.7 to 1.4 ppmC was caused by the fuel supply irregularities with the RTO. As a result, our method reported a TNMHC level of approximately 3.5 ppmC, whereas the filtration method reported approximately 5 ppmC, an overestimate of 40% due to the false results in methane measurements. Since the TNMHC mixing ratios at the outlet are oftentimes the official values to be reported to the regulatory agencies, therefore, in this case, the filtration method would overestimate the level of TNMHC to the extent that is intolerable to both users and regulatory authorities.

CONCLUSION

The filtration method, which is susceptible to saturation by high-boiling-point VOCs and subsequently produces a measurement bias for TNMHC in waste gas, can be improved by implementing a back-flush. The lack of a bake-off procedure with the filtration method inevitably

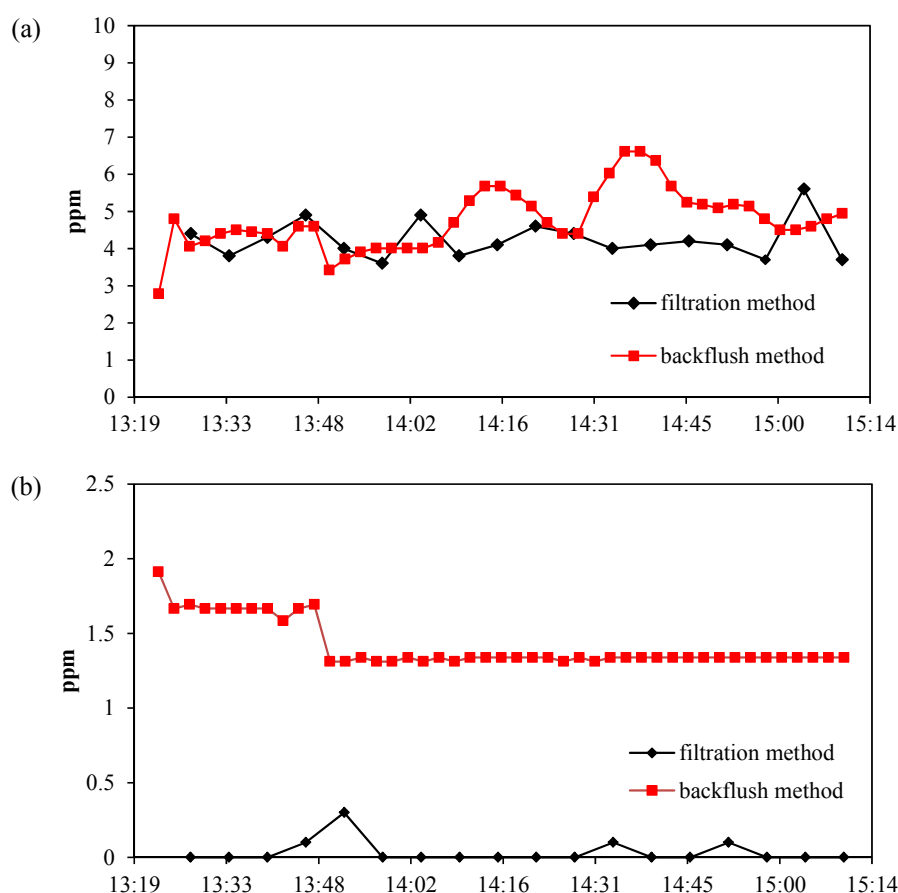

Fig. 7. Continuous monitoring after RTO in a semiconductor fabrication factory. (a) THC measurements; (b) methane measurements.

results in the saturation of porous materials in the filtration column. Our newly designed back-flush method is a typical GC method that uses dual columns—a pre-column and an analytical column—to fully separate methane from TNMHC and even ethane and to clean the pre-column every time an aliquot of a sample is analyzed. The continually refreshed pre-column greatly minimizes column saturation and thus greatly reduces the likelihood of a systematic bias during the CEMS mode.

ACKNOWLEDGEMENTS

This study was financially supported by the Ministry of Science and Technology (formerly National Science Council), Taiwan, through the Contract No. NSC 106-2113-M-008-002-MY3, and Environmental Analysis Laboratory, EPA, Taiwan.

REFERENCES

Alastair, C.L., Nicola, C., Philip, J.M., Russel, M.K., Paul, M., Andrew, L.L., Keith, D.B. and Michael, J.P. (2000). A larger pool of ozone-forming carbon compounds in urban atmospheres. *Nature* 405: 778–781.

Atkinson, R. (1986). Kinetics and mechanisms of the gas-phase reactions of the hydroxyl radical with organic

compounds under atmospheric conditions. *Chem. Rev.* 86: 69–201.

Atkinson, R. (2000). Atmospheric chemistry of VOCs and NO_x . *Atmos. Environ.* 34: 2063–2101.

Chen, X., Hopke, P.K. and Carter, W.P.L. (2011). Secondary organic aerosol from ozonolysis of biogenic volatile organic compounds: Chamber studies of particle and reactive oxygen species formation. *Environ. Sci. Technol.* 45: 276–282.

Chestnut, L.G. and David, M.M. (2005). A fresh look at the benefits and costs of the US acid rain program. *J. Environ. Manage.* 77: 252–266.

Ellerman, A.D. (2000). *Markets for clean air: The US acid rain program*, Cambridge University Press, Cambridge.

EPA, CN (2017). Stationary source emission—Determination of total hydrocarbons, methane and nonmethane hydrocarbons—Gas chromatography. HJ/T 38-2017, Ministry of Environmental Protection, China. <http://kjs.mee.gov.cn/hjbhzb/bzwb/jcffbz/201801/W020180108566316243797.pdf> (in Chinese)

EPA, ROC (2011). Determination of total hydrocarbon and total non methane hydrocarbon concentration using online flame ionization detector method. NIEA A723.73B, Environmental Protection Administration, Taiwan. <https://www.niea.gov.tw/niea/pdf/AIR/A72373B.pdf> (in Chinese)

- Farrell, A., Robert, C. and Roger, R. (1999). The NO_x Budget: Market-based control of tropospheric ozone in the northeastern United States. *Resour. Energy Econ.* 21: 103–124.
- Hallquist, M., Wenger, J.C., Baltensperger, U., Rudich, Y., Simpson, D., Claeys, M., Dommen, J., Donahue, N.M., George, C. and Goldstein, A.H. (2009). The formation, properties and impact of secondary organic aerosol: current and emerging issues. *Atmos. Chem. Phys.* 9: 5155–5236.
- Hatfield, M.L. and Huff Hartz, K.E. (2011). Secondary organic aerosol from biogenic volatile organic compound mixtures. *Atmos. Environ.* 45: 2211–2219.
- Jahnke, J.A. (2000). *Continuous emission monitoring*, John Wiley & Sons, New York, USA.
- Kondratiev, V.N. and NiKitin, E.E. (2012). *Gas-phase reactions: Kinetics and mechanisms*, Springer Science & Business Media Press, Netherlands.
- Kwok, E.S.C. and Atkinson, R. (1995). Estimation of hydroxyl radical reaction rate constants for gas phase organic compounds using structure-reactivity relationship: An update. *Atmos. Environ.* 29: 1685–1695.
- Lee, B. (1991). Highlights of the clean air act amendments of 1990. *J. Air Waste Manage. Assoc.* 41: 16–19.
- Lin, C.M. and Kuo, H.W. (2013). Sex-age differences in association with particulate matter and emergency admissions for cardiovascular diseases: A hospital-based study in Taiwan. *Public Health* 127: 828–833.
- Markelj, J. and Pompe, M. (2016). Modeling of atmospheric OH reaction rates using newly developed variable distance weighted zero order connectivity index. *Atmos. Environ.* 131: 418–423.
- McAlister, G. (1987). Determination of total gaseous nonmethane organic emissions as carbon: Summary of comments and responses for Method 25. Environmental Protection Agency, Research Triangle Park, NC, USA.
- Michael, W.G., Gary, Z.W., James, P.K. and Marcia, C.D. (1989). A photochemical kinetics mechanism for urban and regional scale computer modeling. *J. Geophys. Res.* 94: 12925–12956.
- Napolitano, S., Stevens, G., Schreifels, J. and Culligan, K. (2007). The NO_x budget trading program: A collaborative, innovative approach to solving a regional air pollution problem. *Electr. J.* 20: 65–76.
- O'Dowd, C.D., Aalto, P., Hmeri, K., Kulmala, M. and Hoffmann, T. (2002). Aerosol formation: Atmospheric particles from organic vapours. *Nature* 416: 497–498.
- Placet, M., Mann, C., O.Gilbert, R.O. and Niefer, M.J. (2000). Emissions of ozone precursors from stationary sources: A critical review. *Atmos. Environ.* 34: 2183–2204.
- Popp, D. (2003). Pollution control innovations and the Clean Air Act of 1990. *J. Policy Anal. Manage.* 22: 641–660.
- Ruch, R.B. and John, S.H. (1991). Proactive industrial strategies for the clean air act amendments of 1990. *J. Air Waste Manage. Assoc.* 41: 922–927.
- Shin, H. H., Jones, P., Brook, R., Bard, R., Oliver, K. and Williams, R. (2015). Associations between personal exposures to VOCs and alterations in cardiovascular physiology: Detroit Exposure and Aerosol Research Study (DEARS). *Atmos. Environ.* 104: 246–255.
- Svendsen, G.T. (1998). The US Acid Rain Program: Design, performance, and assessment. *Environ. Plann. C* 16: 723–734.
- Tsai, D.H., Wang, J.L., Chuang, K.J. and Chan, C.C. (2010). Traffic-related air pollution and cardiovascular mortality in central Taiwan. *Sci. Total Environ.* 408: 1818–1823.
- U.S. EPA (1975). 40 CFR Part 60 - Standards of performance for new stationary sources, Office of the Federal Register (OFR), Washington DC.
- United States 101st Congress (1990). Clean air act amendments of 1990. U.S. Government Printing Office, Washington DC, USA.
- Vivanco, M.G., Santiago, M., Martínez-Tarifa, A., Borrás, E., Ródenas, M., García-Diego, C. and Sánchez, M. (2011). SOA formation in a photoreactor from a mixture of organic gases and HONO for different experimental conditions. *Atmos. Environ.* 45: 708–715.
- Wichmann, G., Franck, U., Herbarth, O., Rehwagen, M., Dietz, A., Massolo, L., Ronco, A. and Müller, A. (2009). Different immunomodulatory effects associated with sub-micrometer particles in ambient air from rural, urban and industrial areas. *Toxicology* 257: 127–136.
- Yorifuji, T., Kashima, S., Tsuda, T., Ishikawa-Takata, K., Ohta, T., Tsuruta, K. and Doi, H. (2013). Long-term exposure to traffic-related air pollution and the risk of death from hemorrhagic stroke and lung cancer in Shizuoka, Japan. *Sci. Total Environ.* 443: 397–402.
- Zevenhoven, R. and Pia, K. (2001). *Control of pollutants in flue gases and fuel gases*, Helsinki University of Technology Press, Espoo, Finland.
- Zhang, X. and Jeremy, S. (2011). Continuous emission monitoring systems at power plants in China: Improving SO₂ emission measurement. *Energy Policy* 39: 7432–7438.
- Zhou, G., Wang, Q., Zhong, Q. and Zhao, J. (2018). Status and needs research for on-line monitoring of VOCs emissions from stationary sources. *IOP Conf. Ser. Earth Environ. Sci.* 108: 042029.

Received for review, May 27, 2018

Revised, September 10, 2018

Accepted, September 12, 2018