



## Technical Note

# Effects of Temperature on Electrostatic Precipitators of Fine Particles and SO<sub>3</sub>

Haibao Zhao<sup>1\*</sup>, Yuzhong He<sup>1</sup>, Jiadong Shen<sup>2</sup>

<sup>1</sup> Zhejiang Feida Environmental Science and Technology Co., Ltd., Zhuji 311800, China

<sup>2</sup> Tongji Zhejiang College, Jiaxing 314051, China

## ABSTRACT

The fine particles and SO<sub>3</sub> at the outlets of electrostatic precipitators (ESPs) were measured when the temperature of the flue gas decreased to 90°C on a pilot-scale platform with 50,000 m<sup>3</sup> h<sup>-1</sup> of real flue gas. Based on the test results and scanning electron microscopes (SEMs) of the particulate matter, the mechanism of fine particle change and SO<sub>3</sub> removal was analyzed. The results show that the efficiency of SO<sub>3</sub> removal reaches 73% and the penetration concentration of PM<sub>1</sub> decreases from 0.5 to 0.17 mg m<sup>-3</sup> when the gas temperature decreases from 120–130°C to 90–95°C in a coal-fired power plant.

**Keywords:** Coal-fired power plant; Dust emission; Electrostatic precipitator; SO<sub>3</sub>; PM.

## INTRODUCTION

As air pollution has been a serious problem, the ultra-low emission in China requires that the particles emissions must be less than 10 mg m<sup>-3</sup> (Saeki *et al.*, 2003; Ando *et al.*, 2011; Nicol *et al.*, 2013; Preston *et al.*, 2013; China *et al.*, 2015).

The collection efficiency of electrostatic precipitator (ESP) is over 99.9%. However, the difficulty of charging is one of the major limiting factors for particles collection of ESP (Kato *et al.*, 1994; Yi *et al.*, 2006; Roudier *et al.*, 2013; Afshar-Mohajer *et al.*, 2014; Xu *et al.*, 2015), and the mass concentration at the outlet of ESP was about 50 mg m<sup>-3</sup> with high penetration efficiency of dust particles in the size range of 0.1–1 μm (Tamaru *et al.*, 1998; Misaka *et al.*, 2009). Chang *et al.* (2015) had enhanced particles agglomeration by using a pre-charger to increase mean particle size but without reducing the dust resistivity and taken more power.

There are some ESPs operated at different gas temperatures in coal-fired power plants (Xia *et al.*, 2011; Li *et al.*, 2017), Hitachi Plant Technologies developed a gas treatment system with a low low temperature electrostatic precipitator (LLT-ESP), the moving electrode type ESP with gas temperature of 90°C was described (Misaka *et al.*, 2008). In 2016, the industrial standard of LLT-ESP was implemented in China (JB/T 12591-2016), but there is few study focused

on its mechanism. Thus, this paper will describe the major performances of LLT-ESP and the changes to ESP at different gas temperatures by tests.

## TEST

### Testing Apparatus

#### (1) Pilot-scale Platform

The pilot-scale platform (Fig. 1) was built beside a real coal-fired power plant. The flue gas of the pilot-scale platform was pumped from a 300 MW heat-supply unit in Heibei plant after the economizer, thus ensured that the characters of flue gas in the pilot-scale platform. The flue gas volume is 50,000 m<sup>3</sup> h<sup>-1</sup> in 350°C while 32,221 m<sup>3</sup> h<sup>-1</sup> in 90°C.

The main parameters of LLT-ESP in the pilot-scale platform is shown in Table 1, which includes of the main components of coal and ash, the inlet flue gas parameters during the texts. The LLT-ESP pilot-plan is shown in Fig. 2.

#### (2) Test ESPs in 300–1000 MW Coal-fired Power Plants

The three ESPs were set in Changxing coal-fired plant (Power plant name, the unit capacity is 660 MW), Shangan coal-fired plant (the unit capacity is 660 MW) and Ninghai coal-fired power plant (the unit capacity is 1000 MW) for in-depth study of the performances of LLT-ESP in large units. The main parameters of ESPs and the entrance flue gas parameters are shown in Table 1.

### Experiment Devices and Methods

In this paper, to test the dust concentrations, SO<sub>3</sub> concentrations and dust practical resistivity of LLT-ESP,

\* Corresponding author.

E-mail address: zhaohaibaozj@163.com

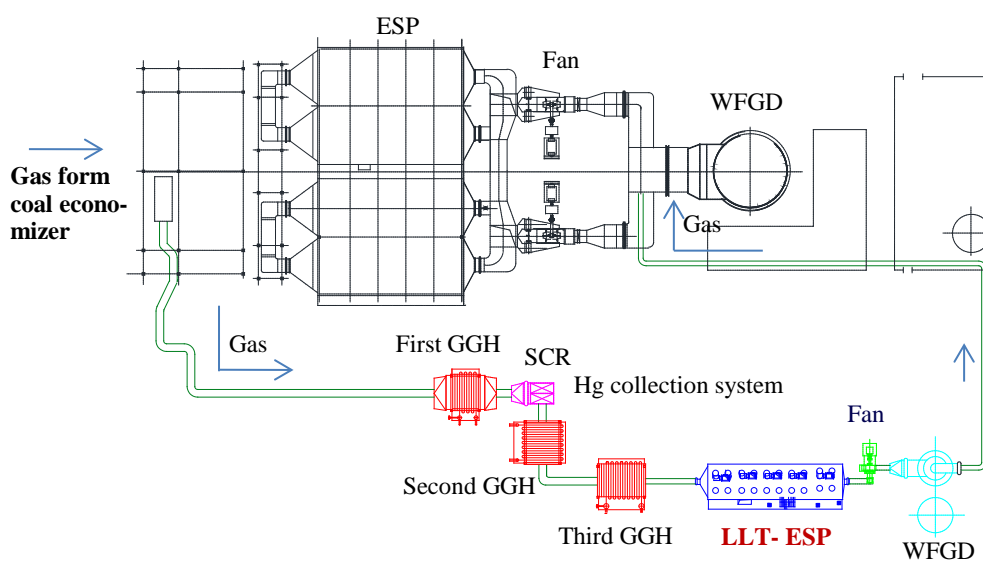

GGH means gas-gas heater, SCR means selective catalytic reduction

Fig. 1. System diagram of pilot-scale platform.

Table 1. Main parameters of LLT-ESPs and flue gas parameters during followed tests.

Item	name	LLT-ESP pilot-plan platform	LLT-ESP in Changxing plant	LLT-ESP in Ninghai plant	LLT-ESP in Shangan plant
Main Parameters of ESPs	Design Dust Collection Efficiency/%	≥ 99.87	≥ 99.782	≥ 99.93	≥ 99.93
	Guaranteed Particle Emission/mg m <sup>-3</sup>	≤ 20	≤ 20	≤ 15	≤ 20
	Number of ESP per boiler, electric field	1, 4+1	2, 5	2, 4	2, 4+1
	SCA of LLT-ESP/m <sup>2</sup> (m <sup>3</sup> s <sup>-1</sup> ) <sup>-1</sup>	124.52	162.1	81.01	85.33+16.33
	power supply	high-frequency	high-frequency	high-frequency + pulsed	high-frequency
Entrance Flue Gas Parameters	Gas Flow Rate/m <sup>3</sup> h <sup>-1</sup>	32221	2742800	8243956	2091580
	Inlet Dust Loading/g m <sup>-3</sup>	15.735	11.55	11.735	28.589
	Gas Temperature/°C	90	88.25	90	95
	D/S	605	195	323	261
Main Components of Coal/%	Moisture	16.20	21.1	14.00	8.1
	Received Base Ash	12.80	6.60	7.04	23.81
	The Yankees Coal Ash Dry Without Volatile Matter Content	37.05	8.82	33.19	15.84
	Carbon	56.32	58.00	63.25	62.39
	Hydrogen	3.40	2.99	3.40	2.97
	Oxygen	10.03	10.13	11.18	2.61
	Nitrogen	0.77	0.61	0.64	0.96
Main Ash Characteristics/%	Sulfur	0.49	0.57	0.50	1.32
	SiO <sub>2</sub>	41.32	42.98	26.31	55.66
	Al <sub>2</sub> O	32.09	27.92	12.66	29.55
	Na <sub>2</sub> O	5.14	2.98	0.43	0.45

the following test data got by the equipment and method are shown in Table 2.

The measurement of dust concentration was on the basis of ISO 12141-2002. The sampling points were set at the inlet and outlet of ESP. The PM was sampled by a normal sample tube, a glass fiber cartridge at the inlet of ESP and by a low concentration sample tube, quartz membranes at the outlet of ESP, respectively. Especially, the gas was sampled with a heating sample tube by isokinetic sampling.

The fiber cartridges or membranes were weighed before and after by an electronic balance in tens of millions.

The measurement method of SO<sub>3</sub> was on the basis of GBT 21508-2008 as shown in Fig. 3. The gaseous SO<sub>3</sub> would become mist SO<sub>3</sub> when the flue gas temperature was reduced under acid dew point by the 60–65°C temperature-controlled water bat, and be collected by the snake-like glass tube, depended on the inertial forces. During the test, the constant temperature should not be lower than 60°C to

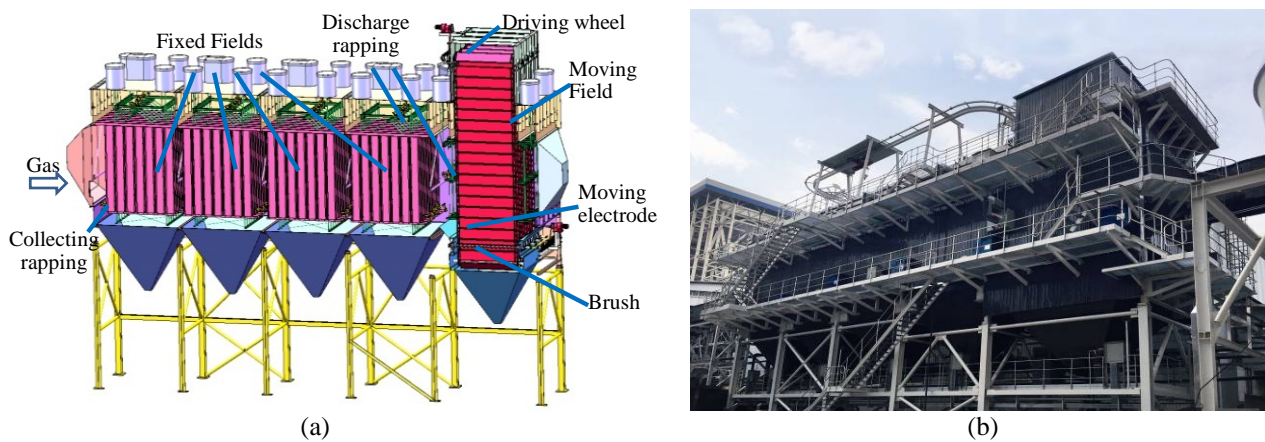

Fig. 2. Sketch of LLT-ESP pilot-plan (a) Schematic diagram and (b) Reality images.

Table 2. The measurement equipment and method (ISO 12141, 2002; GB/T 21508, 2008; GB/T 16913, 2008; JB/T 12591, 2016).

Items	Measurement Equipment	Instrument Types	Reference Standards or Methods
Dust Concentrations	Flue Dust Sampling Instrument, Flue Gas Sampling Gun	Raoying 3012H, 1085B, 1085D	GB/T 16157-1996 GB 13931-2002 ISO 12141-2002
SO <sub>3</sub> Concentrations	Ultraviolet Spectrophotometer, Flue Gas Sampling Gun	Hach DR5000, ZR-D03A	GBT 21508-2008 DL/T 986-2005
Dust Practical Resistivity	Dust Practical Resistivity Tester	TH2681A	GB/T 16913-2008

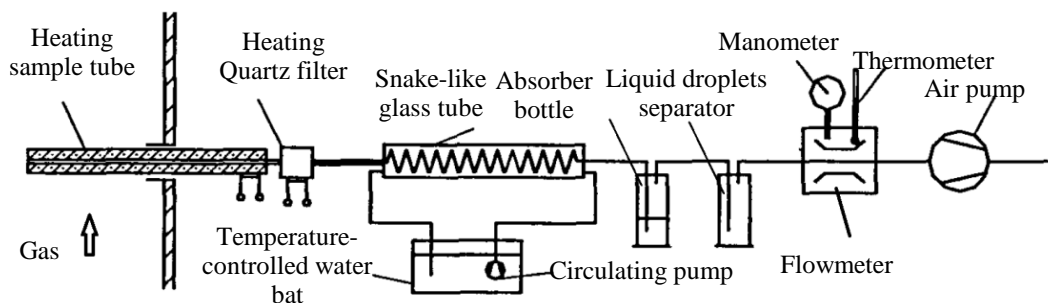

Fig. 3. The measurement method of SO<sub>3</sub>.

prevent SO<sub>2</sub> from being condensed. The heating sample tube was set with a quartz filter or a glass fiber to filter the particulate matter and the heating temperature is not lower than 260°C. The content of SO<sub>4</sub><sup>2-</sup> was tested by titration method with an ultraviolet spectrophotometer.

## RESULTS AND DISCUSSION

### Dust Removal Efficiency with Different Diameters

The result of the tests done on the LLT-ESP pilot-plan is shown in Fig. 4. It showed that the dust concentration via gas temperature and diameter. The sizes of dust particles between GGH and LLT-ESP were growing from 130 to 90°C and the particles ratio of  $\leq 1 \mu\text{m}$ ,  $\leq 2.5 \mu\text{m}$ ,  $\leq 10 \mu\text{m}$  decreased by 65%, 50% and 35% respectively. In general, the dusts whose size was in a range of 0.1–1  $\mu\text{m}$  were difficult to remove (Zhao et al., 2018). When the temperature

reduced, the penetration concentrations of PM<sub>1</sub> decreased from 0.5 to 0.17 mg m<sup>-3</sup>. As the penetration concentration of PM<sub>1</sub> decreases about 65% when the temperature of flue gas decreases to 90°C according to the tests, about 60% of PM<sub>1</sub> has grown up to big particle which was easy to collect by ESP.

As the same trend, the tests of LLT-ESP in Changxing plant (600 MW) showed that the penetration efficiency of PM<sub>1</sub> decreased 65% as the gas temperature decreased from 120 to 90°C as shown in Fig. 5. And the total particles concentration (TPS) were less than 11.5 mg m<sup>-3</sup> at the outlet of LLT-ESP, contrasted with 19 mg m<sup>-3</sup> at the outlet of normal ESP, accorded by the test of Shangan plant.

The LLT-ESP which reduced the gas temperature to near 95°C made a good effect on the performance of ESP and effectively solved the problem of low removal efficiency of fine particles. Moreover, the WFGD would show an

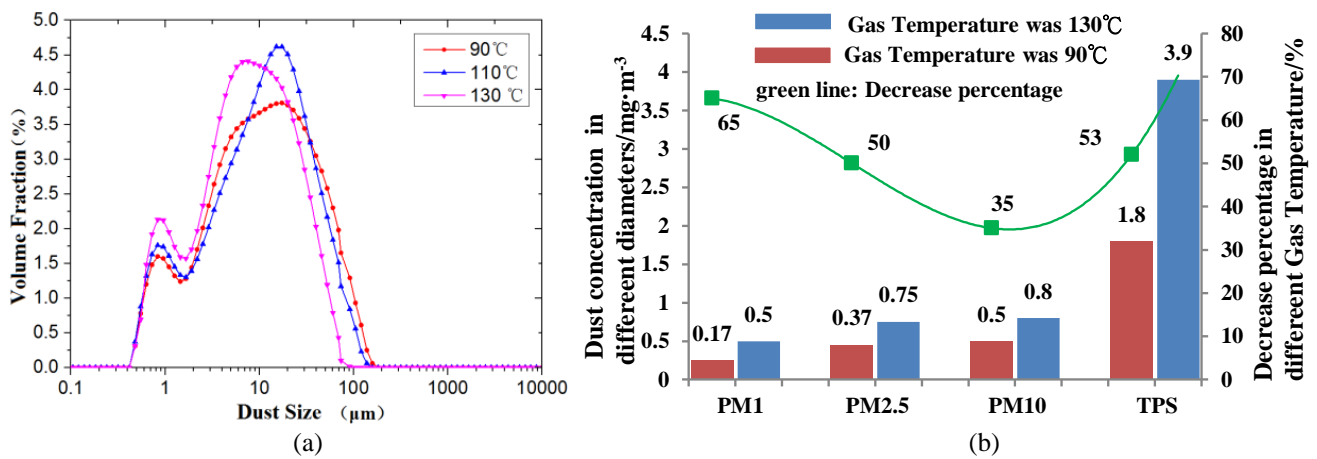

**Fig. 4.** Dust concentration via gas temperature and diameter (a) Sizes distribution of PM at the inlet of ESP and (b) dust removing efficiency of different diameters.

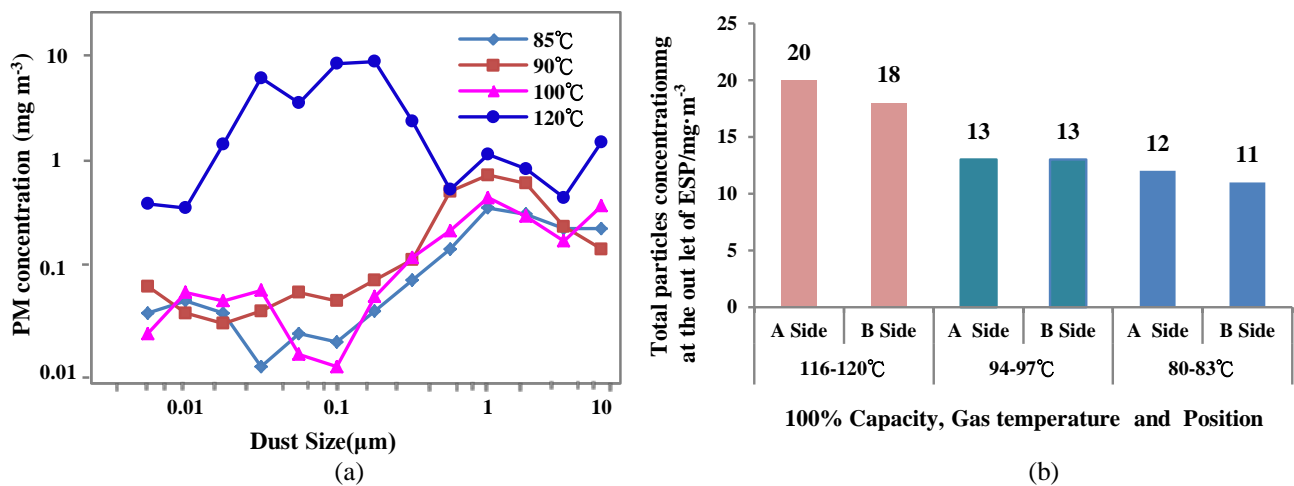

**Fig. 5.** Particulate removal performance vs. gas temperature (a) Changxing plant (600 MW) and (b) Shangnan plant (300 MW).

apparent increase of dust removal efficiency as the particles diameters increased at the inlet of WFGD when took a LLT-ESP (Ondov *et al.*, 1979).

### SO<sub>3</sub> Removal Efficiency

The tests done on the LLT-ESP pilot-plan showed that the removal efficiency of SO<sub>3</sub> was 22.84%, 96.15% and 96.61% when the gas temperature was 120°C, 90°C and 80°C, respectively. Furthermore, the tests done on the LLT-ESP in Changxing plant showed that the removal efficiency of SO<sub>3</sub> achieved 73% by GGH and LLT-ESP, and the SO<sub>3</sub> concentration was less than 6 mg m<sup>-3</sup>, as shown in Fig. 6, while the penetration concentration of PM decreased from 28 to 18 mg m<sup>-3</sup>. SO<sub>3</sub> removal efficiency is increased with LLT-ESP.

### Mechanism Analysis of Fine Particles Change and SO<sub>3</sub> Removal

To analyze the mechanism of fine particles change and SO<sub>3</sub> removal, membranes was set at the inlet of ESP in the pilot-scale platform, and particulate matter was observed

by scanning electron microscope (SEM) as shown in Fig. 7.

Contrast of 120°C, the particulate matters in the gas temperature of 90°C got together, and the fine particulate adhered to coarse particulate.

As the flue gas before ESP includes relatively much PM than SO<sub>3</sub>, the gas SO<sub>3</sub> condensed into SO<sub>3</sub> mist and was condensed on PM when the flue gas temperature was reduced below acid dew point. According the analysis of those SEM images, the rule of condensation, adsorption, the model of fine particles change and SO<sub>3</sub> removal was put forward as shown in Fig. 8, which supports the test results of dust particles grow when the flue gas decreases to 90°C in Fig. 4. At the same time, the SO<sub>3</sub> would be collected together with PM and solved the high penetration rate of SO<sub>3</sub> of normal ESP in 120–130°C.

### CONCLUSIONS

When the gas temperature in a coal-fired power plant decreased from 120–130°C to 90–95°C, the particulate matter aggregated and adhered to coarse particles, and the



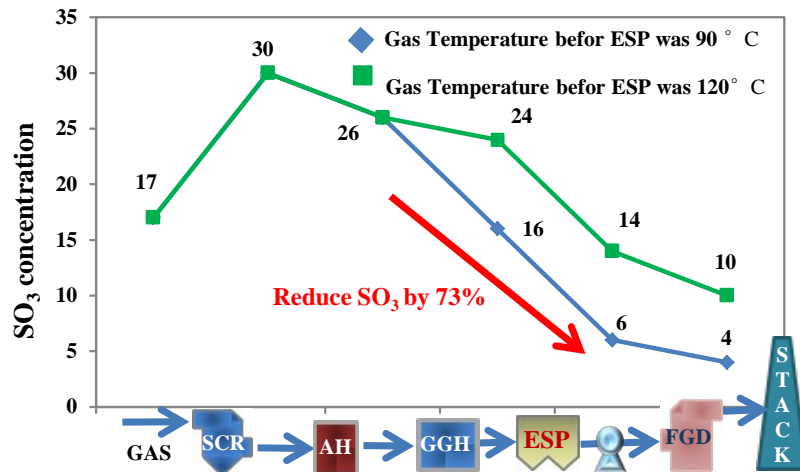

Fig. 6. SO<sub>3</sub> removal performance vs. gas temperature.

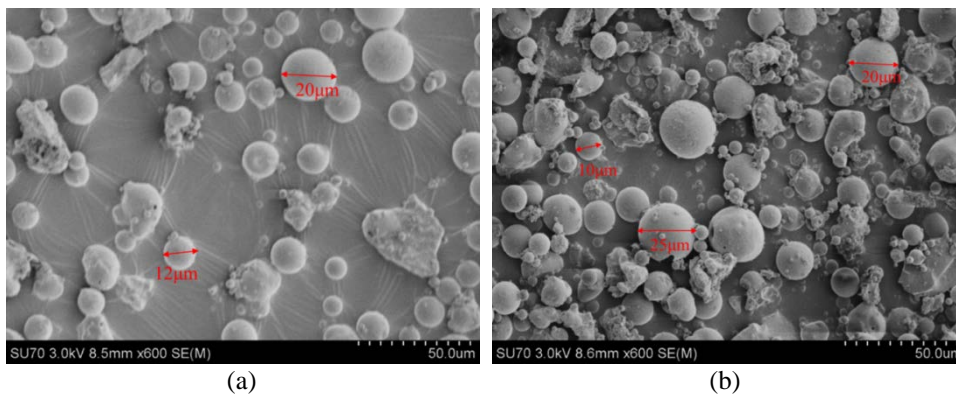

Fig. 7. Contrast of particulate matter with flue gas temperature of 90°C and 120°C (a) Particles morphology in 90°C and (b) Particles morphology in 120°C.

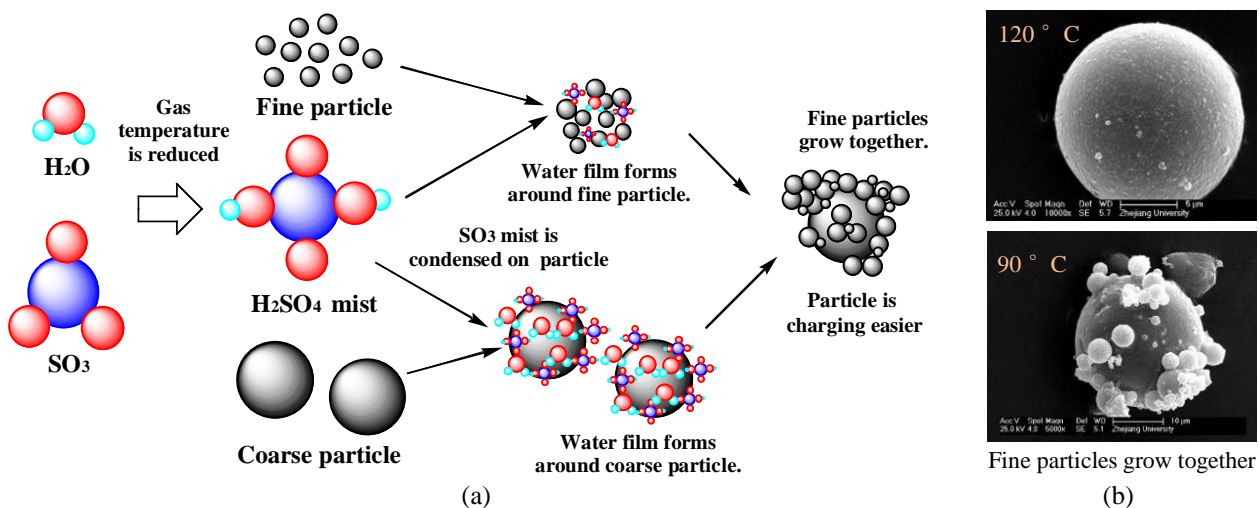

Fig. 8. Model of fine particles change and SO<sub>3</sub> removal (a) Model and (b) SEM images with gas temperature of 90°C and 120°C.

gaseous SO<sub>3</sub> condensed into SO<sub>3</sub> mist and on the PM. The problem of charging fine dust particles was negated by reducing the flue gas temperature below the acid dew point, as most of the PM<sub>1</sub> developed into large particles, which

were easily collected by the ESP. More than 70% of the SO<sub>3</sub> was removed with the PM, and the penetration concentration of the PM<sub>1</sub> decreased from 0.5 to 0.17 mg m<sup>-3</sup>.

## ACKNOWLEDGMENTS

This work was supported by the financial support from National Key R&D Program of China (No. 2017YFB0603202).

## REFERENCES

- Afshar-Mohajjer, N., Thakker, Y., Wu, C.Y. and Sorloaica-Hickman, N. (2014). Influence of back electrostatic field on the collection efficiency of an electrostatic lunar dust collector. *Aerosol Air Qual. Res.* 14: 1333–1343.
- Ando, H., Shiromaru, N. and Mochizuki, Y. (2011). Recent technology of moving electrode electrostatic precipitator. *Int. J. Plasma Environ. Sci. Technol.* 200: 130–134.
- Chang, Q., Zheng, C., Gao, X., Chiang, P., Fang, M., Luo, Z. and Cen, K. (2015). Systematic approach to optimization of submicron particle agglomeration using ionic-wind-assisted pre-charge. *Aerosol Air Qual. Res.* 15: 2709–2719.
- China Association of Environmental Protection Industry. (2015). *Technology of flue gas ultra-low emission for coal-fired power plant*. China Electric Power Press, Beijing.
- GB/T 16913-2008 (2008). Methods of dust character test. General Administration of Quality Supervision, Inspection and Quarantine of the People's Republic of China, Standardization Administration of the People's Republic of China, China. (in Chinese)
- GB/T 21508-2008 (2008). Performance test method for coal-fired flue gas desulphurization equipment. General Administration of Quality Supervision, Inspection and Quarantine of the People's Republic of China, Standardization Administration of the People's Republic of China, China. (in Chinese)
- ISO 12141-2002 (2002). Stationary source emissions-Determination of mass concentration of particulate matter (dust) at low concentrations - Manual gravimetric method. International Organization for Standardization, Switzerland.
- JB/T 12591-2016 (2016). Low-low temperature electrostatic precipitator. Ministry of Industry and Information Technology (in Chinese)
- Kato, M., Tanaka, T., Nishimura, Y., Yata, K., Nakao, M. and Sakai, T., Ohishi, T. and Higashi, T. (1994). Method and system for handling exhaust gas in a boiler. US5282429, US.
- Li, J., He, Y., Liu, H. and Zhao, H. (2017). Characteristics of low-low temperature ESP technology and its application in ultra-low emissions for high-ash coal-fueled power plant. *Electric Power* 50: 28–33. (in Chinese)
- Misaka, T. and Mochizuki, Y. (2008). Recent application and running cost of moving electrode type electrostatic precipitator. 11<sup>th</sup> International Conference on Electrostatic Precipitation. Hangzhou, China.
- Misaka, T. and Mochizuki, Y. (2009). Recent application and running cost of moving electrode type electrostatic precipitator. In *Electrostatic precipitation*, Yan, K. (Ed.), Springer Berlin Heidelberg, Berlin, Heidelberg, pp. 518–522.
- Nicol, K. (2013). *Recent developments in particulate control*. IEA Clean Coal Centre, UK, pp. 29–30.
- Ondov, J.M., Ragaini, R.C. and Biermann, A.H. (1979). Emissions and particle-size distributions of minor and trace elements at two western coal-fired power plants equipped with cold-side electrostatic precipitators. *Environ. Sci. Technol.* 13: 946–953.
- Preston, J.M., Watson, W.R. and Jones, C.B. (2013). Waste/low quality heat recovery and utilization with low temperature economizers. ASME 2013 Power Conference, pp.V001T01A015-V001T01A015.
- Roudier, S., Sancho, L.D., Remus, R. and Aguadomsonet, M. (2013). Best Available Techniques (BAT) reference document for iron and steel production. Industrial Emissions Directive 2010/75/EU: Integrated Pollution Prevention and Control. Institute for Prospective and Technological Studies, Joint Research Centre, European Commission.
- Saeki, M., Inoue, T., Tsukahara, M. and Maehata, H. (2003). Development of electrostatic separator equipped with moving belt electrode. *Trans. Jpn. Soc. Mech. Eng. C* 69: 3358–3363.
- Tamaru, T. (1998). Operation results of IHI flue gas desulfurization system for Unit No. 1 (700 MW) of Reihoku power station of Kyushu Electric Power Co., Inc. *IHI Eng. Rev.* 30: 60–68.
- Xia, J., Peng, P., Zhang, C., Yang, T. and Chen, G. (2011). Study and application of two-level optimization of coal blending for power plant based on on-line coal identification. ASME 2011 Power Conference collocated with JSME ICOPE 2011, ASME 2011 Power Conference, Volume 1, Denver, Colorado, USA, July 12–14, 2011, pp. 221–226.
- Xu, X., Gao, X., Yan, P., Zhu, W., Zheng, C., Wang, Y., Luo, Z. and Cen, K. (2015). Particle migration and collection in a high-temperature electrostatic precipitator. *Sep. Purif. Technol.* 143: 184–191.
- Yi, H., Hao, J., Duan, L., Li, X. and Guo, X. (2006). Characteristics of inhalable particulate matter concentration and size distribution from power plants in China. *J. Air Waste Manage. Assoc.* 56: 1243–1251.
- Zhao, H., He, Y. and Yao, Y. (2018). Study on brush of moving electrode type electrostatic precipitator (MEEP). IOP Conference Series: Earth and Environmental Science 121: 052024.

Received for review, May 28, 2018

Revised, July 19, 2018

Accepted, July 30, 2018